

DR. G. VENKATASWAMY EYE RESEARCH INSTITUTE

Aravind Medical Research Foundation

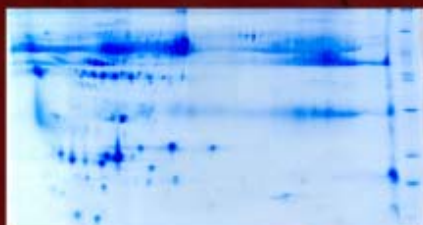

REPORT 2006

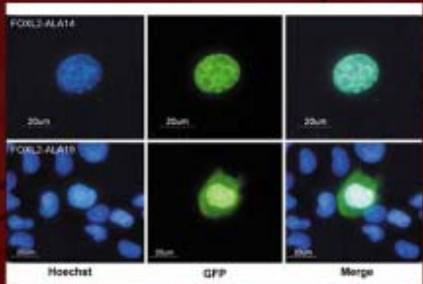
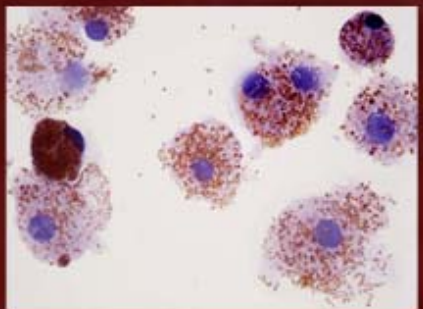
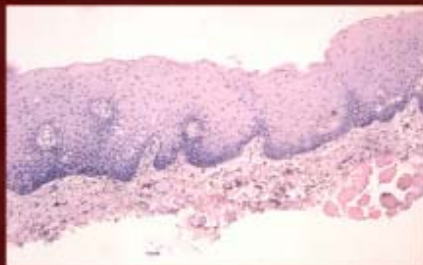

ARAVIND EYE CARE SYSTEM

DR. G. VENKATASWAMY EYE RESEARCH INSTITUTE

Aravind Medical Research Foundation

Report 2006

The research activities at Aravind began within a year of the establishment of the hospital leading to one of the first publications documenting barriers to accessing health care particularly eye care. Since then several research studies have taken place to provide evidence to directly influence service delivery models. Subsequently, re-research activities increased, leading to the formation of a separate organization known as Aravind Medical Research Foundation.

Aravind, known for its service delivery and outreach programmes, is now considered a role model in eye care revolutionizing hundreds of eye care programmes across the developing world.

Over the years, the spectrum of research activities also diversified from epidemiology, clinical research and clinical genetics to basic research and translational research. The importance of basic research on Genetics, Immunology, Microbiology, Cell Biology, Bio Chemistry and Molecular Biology of eye diseases with special reference to Indian context is well recognized and several research programmes are underway with the support of various funding agencies in India and with international collaboration.

Aravind is currently in the process of establishing a new major centre for research – Dr.G.Venkataswamy Eye Research Institute to strengthen and integrate the various research activities. Major programmes on proteomics of vitreous and tear related to eye diseases have also been initiated.

The future activities would involve Functional Genomics, Copy number variation, Single Nucleotide polymorphism, especially in age related eye diseases.



Dr.VR. Muthukkaruppan, Dr. P. Balakrishnan, Dr. R. Kim, Dr. D.K. Mehta, Ms. Alice Crasto, Ms. A. Jancy, Dr. V.M. Loganathan, Dr. P. Namperumalsamy, Dr. S. Aravind, Mr. V. Vijayakumar

ARAVIND MEDICAL RESEARCH FOUNDATION

PRESIDENT

DR. P. NAMPERUMALSAMY, MS, FAMS

VICE-PRESIDENT

DR. G. NATCHIAR, MS DO

SECRETARY & TREASURER

MR. G. SRINIVASAN BE, MS

DIRECTOR – RESEARCH & IMMUNOLOGY

DR. VR. MUTHUKARUPPAN, M.Sc, Ph.D

DEPARTMENT OF GENETICS

SENIOR SCIENTIST

DR. P. SUNDARESAN, M.Sc., Ph.D

DEPARTMENT OF IMMUNOLOGY

JUNIOR SCIENTIST

MS. GOWRIPRIYA CHIDAMBARANATHAN, M.Sc

PH.D PROGRAMME

Recognised by the Tamil Nadu MGR Medical University as a Centre for Ph.D. in Ophthalmology, Aravind has instituted a Ph.D. Programme, under which Dr. S.R. Rathinam, Chief of Uvea Clinic, Aravind Eye Hospital, Madurai has been awarded Ph.D. in 2006. Title of the thesis was “Studies on clinical presentation, diagnosis and management of Infectious uveitis with reference to Leptospirosis”.

Dr. P. Namperumalsamy offered guidance to Dr. S.R. Rathinam in this programme.

Madurai Kamaraj University has recognised Aravind Medical Research Foundation as centre for Ph.D. in Biomedical Sciences.



Dr SR Rathinam receives her PhD award from Tamil Nadu Governor, Thiru Surjit Singh Barnala at the sixteenth convocation of The Tamil Nadu Dr.M.G.R.Medical University

SCHOLARS WORKING FOR PH.D

NAME & REGN YEAR	GUIDE	PROJECT TITLE
C.GOWRIPRIYA 21.11.2002	DR. VR. MUTHUKKARUPPAN	Aetiology and pathogenic Mechanism of Uveitis associated with Leptospirosis Submitted Thesis in November 2006
ARPITHA PARTHASARATHY 25.11.2002	DR. VR. MUTHUKKARUPPAN	Identification, Characterization, Enrichment and in vitro maintenance of human corneal epithelial stem cells submitted thesis in January 2007
G.NEETHIRAJAN 18.12.2002	DR. P. SUNDARESAN	Molecular Analysis of PAX6 Gene in Indian Aniridic patients. Submitted Thesis in April 2006
J.KANAGAVALLI 24.12.2002	DR. P. SUNDARESAN	Studies on Myocilin (TIGR/MYOC) gene mutations and myocilin protein in Indian patients with primary open angle glaucoma Submitted Thesis in December 2006
R.RAMYA DEVI 11.02.2003	DR. P. SUNDARESAN	Differential Gene Expression In age related cataract
J.NALLATHAMBI 30.09.2004	DR. P. SUNDARESAN	Involvement of Transcription Factor genes PAX6/ FOXL2 in various ocular anomalies
T.AMALA RAJA SUNDARI 02.11.2004	DR. P. SUNDARESAN	Determination of Genetic Makeup of Rubella virus infecting children in South India
B.SUGANTHALAKSHMI 26.11.2004	DR. P. SUNDARESAN	Molecular Genetics of Diabetic Retinopathy
B.HEMADEVI 01.02.2006	DR. P. SUNDARESAN	Genetic and Functional analysis of Fuch's Endothelial Corneal Dystrophy (FECD) and Congenital Hereditary Endothelial dystrophy (CHED) in Indian patients
P.MURUGESWARI 20.04.2006	DR. VR. MUTHUKKARUPPAN	Studies on Molecular Mechanism of Diabetic Retinopathy
P.J.JEYA PRITA	DR. VR. MUTHUKKARUPPAN	Corneal surface reconstruction using bio-engineered autologous oral mucosal epithelium
S. NAGASUNDARAPANDIAN	DR. VR. MUTHUKKARUPPAN	Vitreous Proteomics
M. JEYALAKSHMI	DR.VR.MUTHUKKARUPPAN	Will cytoskeletal drugs prevent PCO?
M. VANITHA	DR. VR. MUTHUKKARUPPAN	Bio-Informatics
S. ANANTHI	DR. N.V. PRAJNA	Pathogen host interaction in human mycotic keratitis
K. RENUGADEVI	DR. P. SUNDARESAN	Identification Of Genetic Defects occurring In Indian Oculocutaneous (OCA) And Ocular Albinism (OA) Families.

ONGOING PROJECTS

PATHOGENIC MECHANISM OF UVEITIS ASSOCIATED WITH PAST LEPTOSPIRAL INFECTION

Investigators : Dr. VR. Muthukkaruppan
Dr. SR. Rathinam

Research Scholar : C. Gowri Priya

Funded by : Aravind Medical Research Foundation

Leptospiral aetiology of uveitis has been demonstrated on the basis of presence of anti-leptospiral LPS antibodies in the serum and pathogenic leptospiral DNA in the aqueous humor. The causative factor responsible for the predominant infiltration of neutrophils and the presence of inflammatory cytokines in aqueous humor of these patients has been identified as LPS. On the basis of the following evidences: (a) A significant level of leptospiral LPS was observed in aqueous humor by dot blot using a monoclonal antibody F70-24, (b) The leptospiral LPS in aqueous humor was serovar specific and the same serovar specific antibody was found in serum of the same patient, (c) Leptospiral LPS induced the production of inflammatory cytokines in whole blood cultures and (d) Infiltrating cells from aqueous humor of leptospiral uveitis patients spontaneously produced inflammatory cytokines *in vitro*. The study confirms that leptospiral uveitis is different from other forms of uveitis based on the aetiology and the pathogenic mechanism.

"TWO-PARAMETER ANALYSIS" A PRECISE CORNEAL EPITHELIAL STEM CELL MARKER

Investigators : Dr. VR. Muthukkaruppan
Dr. M. Srinivasan
Dr. NV. Prajna

Research Scholar : Arpitha Parthasarathy

Funded by : Aravind Medical Research Foundation

The novel combination of the two parameters, high expression of p63 combined with a large N/C ratio was used to identify a subset of limbal cells with putative stem cell characteristics (IOVS 2005). The following evidences confirm that the two parameters in combination form a precise corneal epithelial stem cell marker. Isolated limbal basal cells (Known location for stem cells) contained an enriched population of cells positive for the above marker, having high colony forming efficiency. Such cells possess slow-cycling label (BrdU) retaining property.

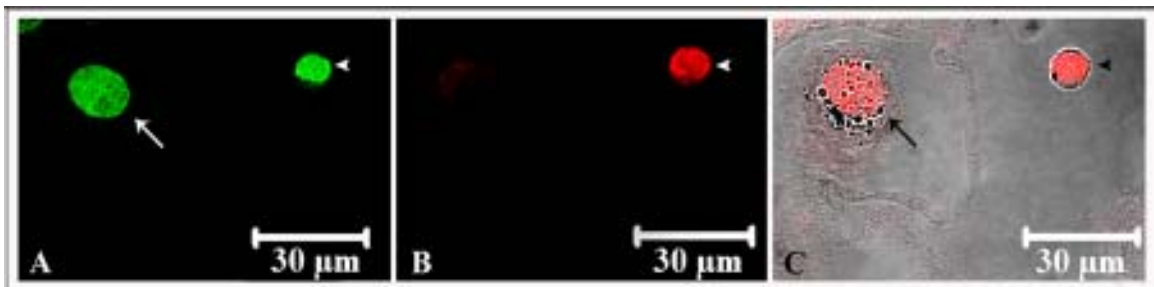

Evaluation Of Label Retaining Property Of Cultured Limbal Epithelial Cells In Relation To Two-Parameter Analysis

Limbal explant cultures were labeled briefly with BrdU followed by chase for 3-weeks. Cytospin smears of cells from the outgrowth were double immunostained for p63 and BrdU and then subjected to two-

parameter analysis. (A) Confocal image after 2D average reconstruction showing 2 cells positive for p63 (green). A small cell (arrow head) with high levels of p63 and high N/C ratio and a large cell with low N/C ratio (arrow). (B) The same field showing BrdU positive (red) LRC (arrow head). Note: The large cell of (A) negative for BrdU. (C) Overlay image of transmitted light and propidium iodide for cells in (A).

IN VITRO AND IN VIVO STUDY ON THE SECRETION OF GLY367ARG MUTANT MYOCILIN PROTEIN

Principal Investigator : Dr. P. Sundaresan

Co-Investigators : Dr. SR. Krishnadas
Dr. S. Krishnaswamy, MKU, Madurai.

Research Scholar : J. Kanagavalli

Funded by : Indian Council of Medical Research

Mutations in the Myocilin gene (*MYOC*) leading to a perturbed outflow of aqueous in the trabecular meshwork (TM) has been associated with the pathophysiology of glaucoma. This study examined the expression of normal and mutant Myocilin (Gly367Arg) in cultured TM cells. Normal and mutant *MYOC* cDNA constructs were used to transfect the TM cells. Western blot confocal microscopic analysis was used to determine the cellular localization of Myocilin protein. Molecular Modeling and Dynamics for the mutant was demonstrated with the native Myocilin model using GROMACS. Gly367Arg mutation causes accumulation of Myocilin protein within TM cells with extensively reduced secretion, in contrast to wild type Myocilin. The secreted Myocilin in the aqueous humor of patients with Gly367Arg mutation correlated with the in vitro findings, confirming the disease-causing glaucomatous phenotype. Further, Gly367Arg mutation occurs in a hydrophobic region causing aggregation, leading to burial of a charged residue resulting in the conformational change to accommodate the mutation. Our results suggest that Gly367Arg is a potential mutation causing malfunction of TM cells either by dominant negative effect or gain of function of mutant Myocilin. The structural model indicates the aggregation of Myocilin protein confirming the pathogenic significance of Gly367Arg/mutation.

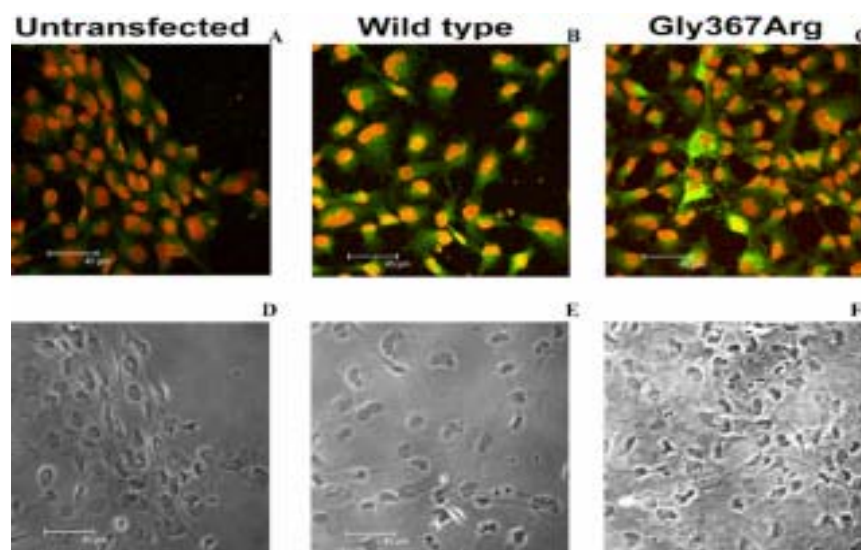

Confocal microscopic image of TM cells transfected with wild type and mutant Myocilin. **A.** Untransfected TM cells showed no endogenous expression of Myocilin. **B.** The TM cells showed wild type Myocilin expression in the perinuclear region. **C.** Intense staining of Gly367Arg mutant Myocilin in the perinuclear region of TM cells. **D-F.** Phase contrast images of panels A-C respectively.

MOLECULAR STUDY ON CONGENITAL RUBELLA SYNDROME IN SOUTH INDIAN POPULATION

Investigators : Dr. P. Sundaresan
Dr. P. Vijayalakshmi

Collaborators : Dr. David Brown
Dr. Li Jin
Health Protection Agency, London

Research Scholar : T. Amala Raja Sundari

Funding : World Health Organization, Geneva
ORBIS International, New Delhi

Congenital rubella Syndrome accounts for significant rate of mortality and morbidity in south India since the vaccination is not mandatory. The main objective of the study is to apply molecular technique such as Real-Time (RT) and nested Block-Based (BB) PCR for detecting the rubella viral RNA in clinical specimens from suspected CRS infants with ocular anomalies. Part of the study has been carried out at Health Protection Agency, London by Ms. Amala.

Samples between age group 0-59 months from IgM IgG positive, IgG positive only and IgM IgG negative categories were investigated. The viral RNA was detected in 85% cases of age between 0-11 months who were sero-positive for both anti-rubella IgM and IgG. High percentage of positivity was observed in lens material and oral fluid samples. The positive samples were sequenced and the data was analyzed using DNA star and seqman software program. Totally, 41 samples from 26 cases were sequenced and showed significant diversity.

Training on Rubella virus culture was also carried out in vero and RK13 cell line using Lab adapted positive Judith strain and the confirmation of viral growth was done by Immunofluorescence and nested BB-PCR.

IDENTIFICATION OF CANDIDATE GENES AND SCREENING FOR POLYMORPHISMS OF GENES ASSOCIATED WITH TYPE II DIABETIC RETINOPATHY

Investigators : Dr. P. Sundaresan
Dr. P. Namperumalsamy
Dr. R. Kim
Dr. Anand Rajendran

Research Scholar : B. Suganthalakshmi

Funded by : TIFAC-CORE in Diabetic Retinopathy
Aravind Medical Research Foundation

India is crowned as a diabetic capital. Diabetic Retinopathy is a most frequent microvascular complication of diabetes and the leading cause of acquired blindness in developed countries. Diabetic patients with microvascular disease have increased profile of gene expression and enzyme activity, which may be due to variants in the genes encoding angiogenic growth factors and the enzymes involved in the biochemical pathway. To identify the polymorphisms in genes associated with type 2 diabetic retinopathy, 176 Diabetic retinopathy (DR) and 120 diabetic without retinopathy (DNR) samples were screened for polymorphisms in aldose reductase gene (ALR) gene.

Two novel promoter polymorphisms have been identified in ALR gene. The heterozygous genotype of one of the polymorphisms showed higher odds ratio and was found to be significantly associated with DR when compared to DNR.

The aldose reductase activity (AR) in erythrocytes was carried out in 15 DR and 15 DNR study subjects with the help of Dr. Bhanuprakash reddy in National Institute of Nutrition (NIN), Hyderabad. The AR activity was higher in both DR and DNR group (>5u/g Hb) when compared with the control samples (2.89u/g Hb, n=500) of NIN. There is no difference in AR activity between DR and DNR groups. Further studies are underway with larger sample size.

STUDIES ON THE PROANGIOGENIC AND VASCULAR GROWTH FACTORS IN RELATION TO THE PATHOGENESIS OF EALES' DISEASE AND DIABETIC RETINOPATHY

Principal Investigator : Dr. VR. Muthukkaruppan

Co-investigators : Dr. P. Namperumalsamy
 Dr. D. Shukla
 Dr. R. Kim
 Dr. R. Anand

Research Scholar : P. Murugeswari

Funded by : TIFAC-CORE and Department of Science and Technology

Giemsa stained cytopsin smear of RPE Cells

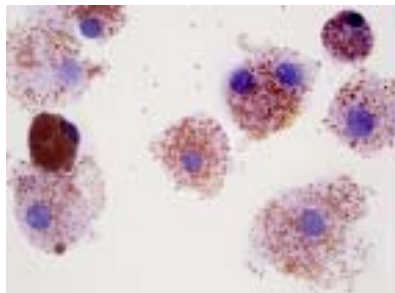

Cadaver RPE cells

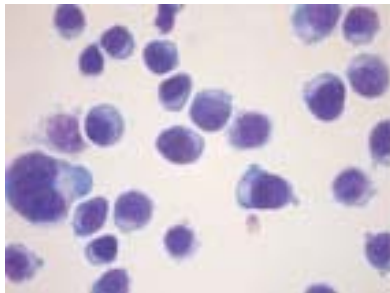

RPE D407 cell line

To understand the pathogenic mechanism of Diabetic Retinopathy, earlier we demonstrated the levels of Proinflammatory cytokines (IL-6, IL-8, IL-1B), Chemokine factor (MCP-1), angiogenic growth factor (VEGF) and antiangiogenic factor (PEDF) in the vitreous, aqueous and serum of Proliferative diabetic retinopathy, Eales' disease and Macular Hole patients. Diabetic retinopathy is also an inflammatory disease as reported earlier. As PEDF is secreted by RPE cells we are interested in studying the cytokines and growth factors secreted by RPE cells.

Phase Contrast images showing live cultures of Retinal Pigment Epithelium

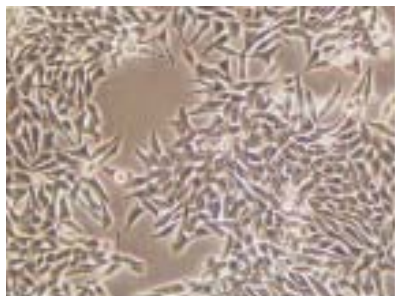

RPE D407 cell line 4-day confluent culture

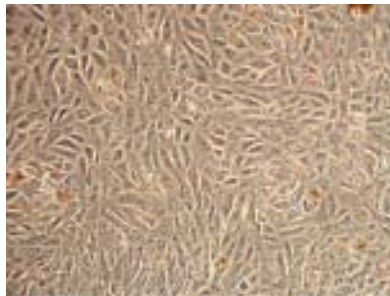

Cadaver RPE cells 28-day confluent culture

Cytokine levels in the conditioned medium of Retinal Pigment Epithelium (RPE)

- In conditioned medium of primary cultures, constitutive expression of IL6, IL8 and VEGF was observed.
- In the RPE D407 cell line constitutive expression of IL6 and VEGF were observed

MOLECULAR GENETIC ANALYSIS OF AUTOSOMAL RECESSIVE CONGENITAL HEREDITARY ENDOTHELIAL DYSTROPHY

Principal Investigator : Dr. P. Sundaresan

Co-Investigators : Dr. M. Srinivasan
Dr. J. Arun Kumar

Research Scholar : B. Hemadevi

Funded By : Aravind Medical Research Foundation & Singapore Eye Research Institute

Pedigree of Family 1

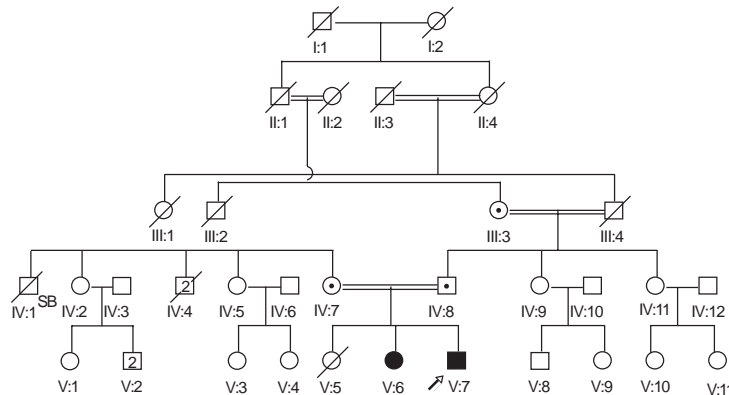

RFLP analysis of R869C mutation

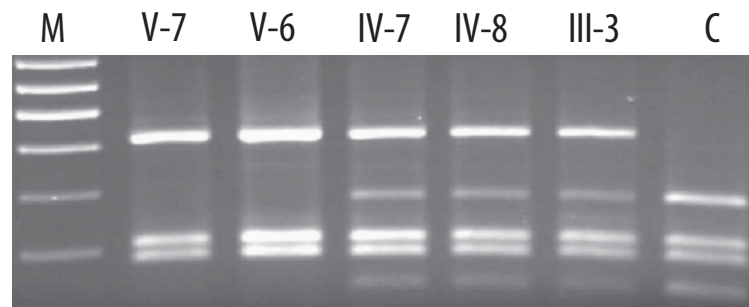

M-Marker, C-Control

Congenital Hereditary Endothelial Dystrophy (CHED) is a heritable disorder of the corneal endothelium characterised by bilateral, diffuse corneal clouding, which impairs visual acuity, occurring at or soon after birth. CHED can be Autosomal dominant (CHED1 [MIM %121700]) or Autosomal Recessive (CHED2 [MIM %217700]) with the later being more common and severe. Both CHED1 and CHED2 map to chromosome 20 at two distinct loci. This collaborative study has identified SLC4A11 as a novel candidate gene for CHED2 (*Nat.Genet.*2006).

Further, we have been screening CHED2 families for mutations in this gene. As a result of screening, in the Family 2, nonsense mutation was identified causing a premature stop at codon 605 (R605X). Two missense mutations R869C and R755Q were identified in Family 1 and Family 3 respectively. In addition R755 and R869 residues were highly conserved among

orthologs and paralogs. In family 4, a 4bp deletion (353_356delAGAA) results in an aberrant truncated protein of 128 residues. In Family 5, a deletion insertion in intron 15 (IVS15 -6_-16 delins GGCCGGCCGG) was identified. None of these mutations were identified in 50 controls. The identification of mutations in all families analyzed in this study indicates that the recessive CHED is genetically homogeneous.

RFLP analysis was carried out using Msp1 restriction enzyme. The Proband (V-7) and his sister (V-6) were homozygous for the R869C mutation while their parents (IV-7, IV-8) and grandmother (III-3) were heterozygous for the mutation.

GENETIC AND FUNCTIONAL ANALYSIS OF *FOXL2* GENE IN INDIAN PATIENTS WITH BPES SYNDROME.

Principal Investigator : Dr. P.Sundaresan

Co-Investigators : Prof. Reiner A. VEITIA
Génétique-Génomique
Professeur de Université Paris VII
Faculté de Médecine Port Royal/ Hôpital Cochin
24, rue de Faubourg St.Jacques. 75014 Paris
Dr.Usha Kim

Research Scholar : J. Nallathambi

Funded By : French Embassy New Delhi and EGIDE France.

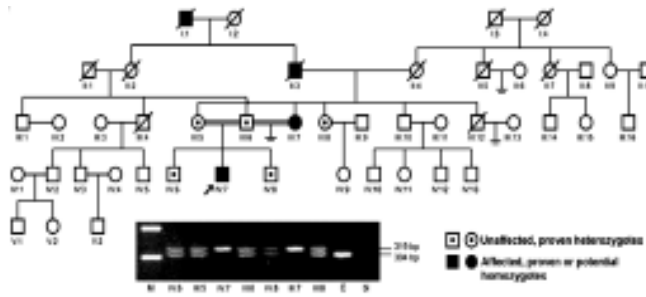

The blepharophimosis syndrome (BPES) is an autosomal dominant developmental disorder in which craniofacial/eyelid malformations are associated (type I) or not (type II) with premature ovarian failure (POF). Mutations in the *FOXL2* gene, encoding a forkhead transcription factor, are responsible for both types of BPES. Heterozygous polyalanine expansions of +10 residues (*FOXL2*-Ala24) account for 30% of

FOXL2 mutations and are fully penetrant for the eyelid phenotype. Here we describe the first homozygous *FOXL2* mutation leading to a polyalanine expansion of +5 residues (*FOXL2*-Ala19). This novel mutation segregates in an Indian family where heterozygous mutation carriers are unaffected whereas homozygous individuals have the typical BPES phenotype, with proven POF in one female. Expression of the *FOXL2*-Ala19 protein in COS-7 cells revealed a significantly higher cytoplasmic retention compared to the wild-type protein. This is the first study providing genetic evidence for a recessive inheritance of BPES associated with ovarian dysfunction (published in *Human genetics*, November 2006).

Pedigree of the Five-generation consanguineous Indian family in which a typical BPES phenotype in homozygous individuals (Individuals I:1 and II:3 were represented as affected based on family history). *Bottom*; Agarose gel electrophoresis (3%) of a PCR amplicon shows segregation of *FOXL2*-polyAla19 expansion c.684-698dup15 (p.A228_A232dup) in two affected and five unaffected individuals. *M* 100 bp DNA marker, *C* unrelated healthy control; the *number symbols* refer to the pedigree, *Bl* negative control for PCR reaction. Unaffected individuals III:5, III:6, III:8, IV:6 and IV:8 carry a wild type and an expanded allele (PCR fragment of 304 and 319 bp, respectively); affected individuals are homozygous for the expanded allele and the control individual only carries a wild type band.

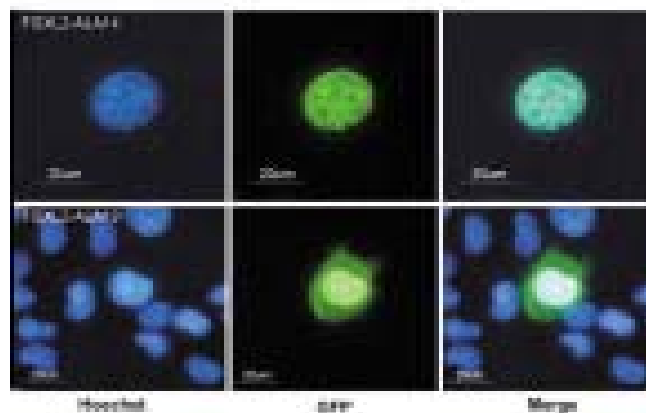

Subcellular localization of *FOXL2*-Ala19. COS-7 cells were transfected with constructs driving overexpression of *FOXL2*-Ala14 (wild type), Ala19 and Ala24 fused to the GFP. *FOXL2*-Ala24 was included for comparison. After 48 h of transfection *FOXL2*-Ala19 was mislocalized in the cytoplasm in 15% of transfected cells but did not induce significant intranuclear aggregation (compared to the effect of Ala24).

NEW PROJECTS

PATHOGEN HOST INTERACTION IN HUMAN MYCOTIC KERATITIS

Principal Investigator : Dr. N. Venkatesh Prajna

Co Investigators : Dr. K. Dharmalingam
Sr. Professor & Head
School of Biotechnology
Madurai Kamaraj University
Dr. S. Lalitha

Research Scholar : S. Ananthi

Funded by : Department of Biotechnology, Government of India

Fungal keratitis is an important cause of corneal blindness in India. The purpose of this study was to elucidate the alterations in the tear proteins of fungal keratitis patient, which may have a bearing on pathogenesis. Tear samples were collected from culture positive fungal keratitis patients. Tears from the fellow eye and from other healthy individuals served as controls. Two-dimensional (2D) electrophoresis was used for separation of fractionated infected tear proteins and control tear proteins. MALDI TOF based detection of selected protein spots were performed from the gels. A MASCOT search engine was used for further identification of proteins.

The Glutaredoxin related protein was expressed only in the tears of fungal keratitis patients. Six other normal tear proteins were present in both samples, but with varied expression. Secretory actin-binding protein and Serum albumin precursor were up-regulated in the infected samples. Cystatin S precursor, cystatin SN precursor, cystatin and human tear lipocalin were down regulated in the infected samples.

Glutaredoxin related protein is known to be produced by *Aspergillus fumigatus* during oxidative stress conditions and presence of this protein in the tears of patients with fungal keratitis is of considerable interest.

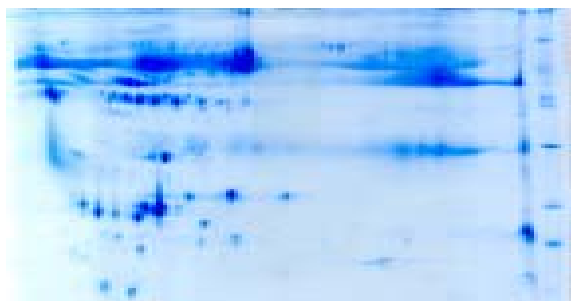

250 μ g of deoxycholate precipitated *Aspergillus* infected tear sample was loaded. IEF was performed using IPG pH 3-10 NL strips, followed with 12% SDS-PAGE and Coomassie G250 stained. The position of molecular mass markers on right side and position of pI on the top of the gel is shown.

IDENTIFICATION OF GENETIC DEFECTS OCCURRING IN INDIAN OCULOCUTANEOUS (OCA) AND OCULAR ALBINISM (OA) FAMILIES

Principal Investigator : Dr. P. Sundaresan
Co-Investigator : Dr. Vijayalakshmi Perumalsamy
Dr. Asim Kumar Sil
Research scholar : K. Renugadevi
Funded by : Department of Biotechnology

The purpose of this study is to detect albinism gene exonic mutations and its Co-inheritance in Indian Oculocutaneous (OCA1) or Ocular albinism (OA1) families. We have so far collected 98 DNA samples from patients.

The objectives are

1. Linkage analysis using the genetic markers near each known albinism genes on chromosomes 5,6,9,11,15 & X for Oculocutaneous and Ocular albinism patients in India.
2. To develop a rapid diagnostic method for albinism (OCA1/OA1) using PCR-RFLP for early carrier detection and genetic counseling for patients.

BIOINFORMATICS IN OPHTHALMOLOGY

Development of Data mining techniques using variety of data structures on eye diseases in Indian population and software development in relation to medical diagnostics for image analysis

Investigator : Dr. VR. Muthukkaruppan
Collaborator : Dr. S. Krishnasamy
Madurai Kamaraj University
Research Scholar : M. Vanitha
Funded by : Aravind Medical Research Foundation

Among the “New Kinds of Science” emerging from the convergence of computing and science, a crucial role is played by BIOINFORMATICS. Bioinformatics can provide its support to diagnostic medicine, especially in imaging systems, developing databases on eye diseases. Ophthalmology is no exception to this. The use and advantages of bioinformatics can be utilized.

The purpose of this project is to develop database on Eye diseases and in particular to start with Primary Open Angle Glaucoma. Aravind Eye Care System has enormous number of data in all levels, Clinical, epidemiological and as well genetic analysis. Database can be created using programming skills and softwares. Zope is an open source application server for building content management systems, intranets, portals, and custom applications. Using PostgreSQL and Python scripts a database will be created with Genetic, Clinical and Epidemiological data in a single source. With regard to software development, Electronic Medical Records can be maintained in Aravind Eye Care System, so that data-base management will be much easier

WILL CYTOSKELETAL DRUGS PREVENT POSTERIOR CAPSULE OPACIFICATION?

Principal Investigators : Dr. VR. Muthukkaruppan
Dr. Baohe Tian, Department of Ophthalmology and Visual Sciences,
University of Wisconsin-Madison, (UW), USA

Co-Investigator : Dr. Hari Priya

Research Scholar : M. Jeyalakshmi

Funded by : National Eye Institute, NIH, USA

The main objective of the project is to determine whether the cytoskeletal drugs LAT-B or H-7 would help in clearing all the lens epithelial cells during cataract surgery in cadaver human eyes. The experiments are designed to evaluate the number/area of residual lens epithelial cells immediately after surgery with and without treatment by cytoskeletal drugs. The second set of experiments will study the effects of cytoskeletal drugs on proliferation and migration of lens epithelial cells in cultured human lens capsular bag after cataract surgery. The PCO and accompanying changes in the cultured lens capsule will be observed under a microscope for several weeks.

If we could demonstrate the efficacy of this drug in removing the residual lens epithelial cells and reducing the levels of PCO in culture, it is possible to have a safe and effective means to reduce incidence of PCO and consequent decrease in post operative vision following cataract surgery in humans.

CORNEAL SURFACE RECONSTRUCTION USING BIO-ENGINEERED AUTOLOGOUS ORAL (BUCCAL) MUCOSAL EPITHELIUM

Investigators : Dr. VR. Muthukkaruppan
Dr. N. Venkatesh Prajna
Dr. Usha Kim
Dr. M. Srinivasan

Research Scholar : P. J. Jeya Prita

Funded by : Defence Research and Development Organization –
Life Science Research Board (DRDO – LSRB)

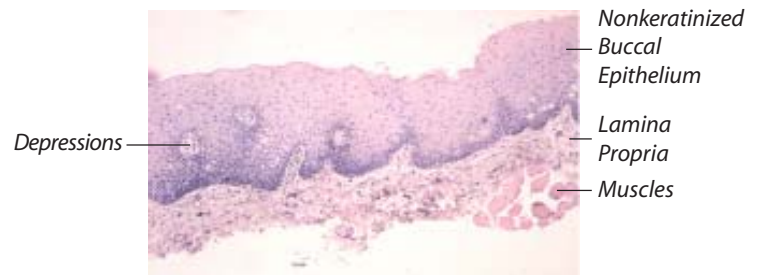

Buccal Mucosal Epithelium stained with Hematoxylin and Eosin

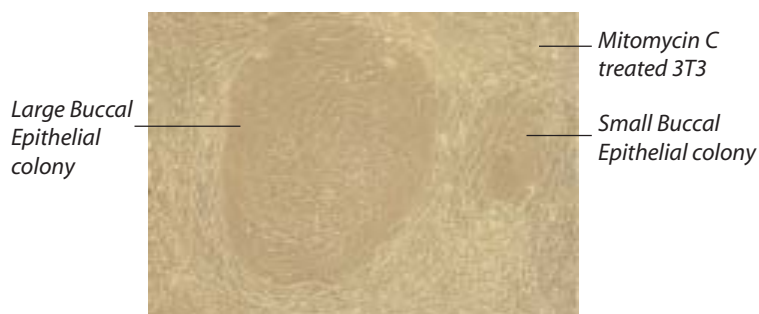

Buccal Epithelial cell colony cultivated with mitomycin treated 3T3 as feeder cells.

The purpose of this study is to generate buccal epithelial sheet by culturing patient's own buccal mucosal epithelium under appropriate culture conditions that will be transplanted onto the cornea of the patient with total limbal stem cell deficiency. This study aims at characterising the cellular profile and to analyze the presence of stem cells in the bioengineered buccal mucosal epithelial sheet on the basis of expression of various markers like p63, Cytokeratin 3, 5, 10, 12, 14, 19, Cx43 and ABCG2 and high N/C ratio and comparing them with the limbal and corneal epithelial stem cells. It is possible to generate large colonies from isolated buccal mucosal epithelial cells.

APPLICATION OF MULTIPLEX PCR IN THE DIAGNOSIS OF INFECTIOUS RETINITIS

Investigators : Dr. Lalitha Prajna
Dr. Rathinam SivaKumar
Dr. R.Kim

Funded by : ICMR

The main goals of this project are to detect the causative agents like Herpes virus, Cytomegalovirus and Varizella zoster virus in cases of infectious uveitis and retinitis by multiplex PCR for more rapid results.

The Ocular Microbiology Laboratory has established molecular based diagnosis using Polymerase chain reaction techniques for the common infectious agents of the eye. Nested PCR is also used which helps to increase the specificity of the tests. These tests are capable of detecting viral infections like Herpes virus, Cytomegalovirus and Varizella zoster virus, parasitic like toxoplasmosis and common bacterial and fungal infections. Techniques are also available for the detection of *Propionibacterium acnes* and *Mycobacterium tuberculosis*. Nested PCR is useful for the diagnosis especially in ocular tuberculosis where routine microbiological culture is not always feasible. We have tested 20 suspected ocular tuberculosis patient's samples and based on these results it was possible to start specific therapy. The number of samples with suspected viral etiology that was tested by nested PCR was 30.

RESEARCH ADVISORY COMMITTEE

Aravind Medical Research Foundation has been approved as a Scientific and Industrial Research Organization by the Department of Scientific & Industrial Research (DSIR), Government of India. Aravind Research programmes are reviewed by a Research Advisory Committee consisting of the following members.

RESEARCH ADVISORY COMMITTEE MEMBERS

DR. P. NAMPERUMALSAMY, Chairman, Aravind Eye Care System
DR. A. GNANAM, Former Vice Chancellor, Pondicherry University
DR. K. DHARMALINGAM, Sr.Professor & Head, Department of Genetic Engineering, Madurai Kamaraj University, Madurai
DR. C.N. PARAMASIVAN, Deputy Director, Tuberculosis Research Centre, Indian Council of Medical Research
DR. L. THAYUMANAVAN, Gastroenterologist, Vadamalayan Hospital, Madurai
DR. K. ANANDA KANNAN, Former Vice Chancellor, The TN Dr. MGR Medical University
DR. VR. MUTHUKKARUPPAN, Director – Research, Aravind Medical Research Foundation
MR. G. SRINIVASAN, Hony. Secretary & Treasurer, Aravind Eye Care System
DR. N.V. PRAJNA, Clinician Scientist, Aravind Eye Care System

INSTITUTIONAL REVIEW BOARD

All the research projects undertaken by AMRF and by other constituents of Aravind Eye Care System are critically evaluated for ethical issues by the Institutional Review Board (IRB) which has the following members.

CHAIRMAN

DR. K. DHARMALINGAM, Sr.Professor & Head, Department of Genetic Engineering, Madurai Kamaraj University, Madurai

MEMBER SECRETARY

DR. SR. RATHINAM, Chief, Uvea Clinic, Aravind–Madurai

MEMBERS

MR. V. SARANGAPANI, Advocate, Madurai
MS. SHOBANA RAMACHANDRAN, Managing Director, TVS Sri Chakra Ltd., Madurai
DR. T.S. CHANDRASEKARAN, Ophthalmologist, Gandhi Nagar, Madurai
DR. C. SRINIVASAN, AICTE, Emeritus Professor, Department of Material Sciences, Madurai Kamaraj University, Madurai
DR. L. THAYUMANAVAN, SR.GASTROENTEROLOGIST, Vadamalayan Hospital, Madurai

VISITORS 2006

Dr. Pritindir Kaur, Peter MacCallum Cancer Center, Australia visited on 2nd January 2006 for discussion on Epithelial Stem Cells. She gave a seminar on "Epidermal Stem Cell biology" at Department of Biotechnology, Madurai Kamaraj University

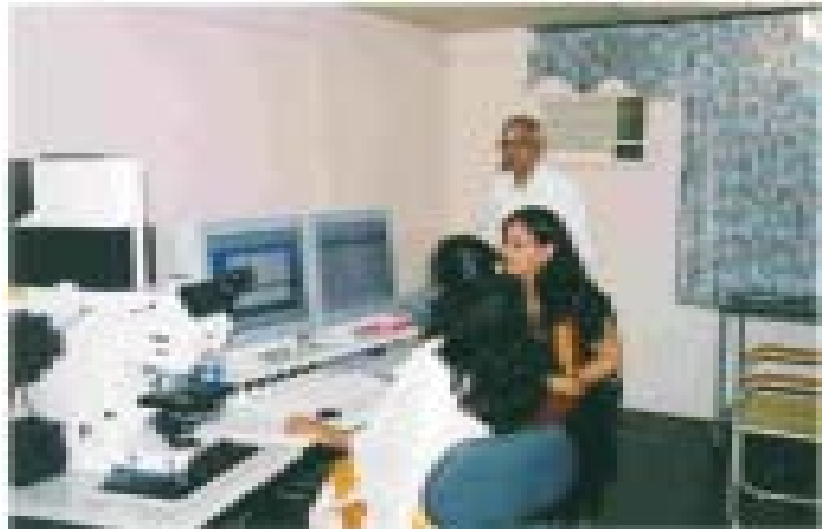

Dr. M. Ramanathan, Professor of Pharmacology, PSG College of Pharmacy, Coimbatore gave a guest lecture on "Understanding the role of neuronal mediators in neurodegenerative processes" on 9th March 2006.



Dr. Dorothea Nitsch, Clinical Lecturer, Department of Epidemiology and population Health, London School of Hygiene and Tropical Medicine, London visited on 15th March 2006 for discussion about INDEYE project on Genetics of age related cataract and age related macular degeneration. She also gave a seminar on "Mendelian Randomization"



TIFAC-CORE Monitoring Committee visited in March 2006 for discussion on the progress of Research activities on Diabetic Retinopathy



Dr. Xu ling, Director of Research Division, HE Eye Hospital, China visited during September 2006. She gave a seminar on the research programmes of her Institute.



VISITS ABROAD

THE 6TH INTERNATIONAL SYMPOSIUM OF OPHTHALMOLOGY AND THE 7TH ASIA PACIFIC SOCIETY OF EYE GENETICS SYMPOSIUM (APSEG)

Hong Kong, 13-15 August 2006

PROFESSOR C.P.PANG, Department of Ophthalmology and Visual Sciences, The Chinese University of Hong Kong, organised the APSEG meeting and invited **Dr. P. Sundaresan** to give a talk on *“Molecular genetics on hereditary Glaucoma and in vitro expression of mutant myocilin gene in trabecular meshwork cells”* in the APSEG symposium.



Dr.P.Sundaresan with Dr.Mansoor Sarfarazi (USA), Dr.Tara Prasad Dass (LV Prasad, Hyderabad), Dr.Shomi S.Bhattacharya (UK), Dr.C.P.Pang (Hong Kong), Dr.Vincent Richmond (Canada) and Dr.Natarajan (Mumbai)



Ms. Amala with Dr. Li Jin, Molecular Virologist, UK (Left) and all IDU staff HPA, London, UK



Mr.J.Nallathambi and Prof. Reiner A Veitia, Université Denis Diderot/ Paris VII, Institut Cochin. Faculté de Médecine. 24 rue du Faubourg Saint Jacques. 75014 Paris

DR. P .SUNDARESAN, presented the above talk and met several senior researchers especially, Dr. C.P. PANG, The Chinese University of Hong Kong, Dr. Tin Aung, Dr. Eranga Vithana, Dr. Roger Beuerman from Singapore Eye Research Institute, Dr. Mansoor Sarfarazi (Molecular ophthalmic Genetics Laboratory, University of Connecticut Health Center, Farmington, CT USA), Dr. Vincent Raymond, (Eastern Quebec Genomics Center, Quebec city, Canada) and Dr. Shomi Bhattacharya (Department of Molecular Genetics, Institute of Ophthalmology, University college London, UK) and discussed about Corneal dystrophies, Glaucoma and Diabetic Retinopathy research projects and explored the possible ways for collaborative projects on inherited eye diseases.

MS. T. AMALA RAJASUNDARI, Ph.D Research scholar at AMRF has undergone training at Health Protection Agency (HPA), London for three months (March 06 to May 06) under the supervision of Dr. Li Jin, Molecular Virologist. The aim of this training was to carry out the molecular testing in the Congenital Rubella Syndrome (CRS) samples collected at Aravind Eye Hospital, India and to get practical training in rubella virus culture and molecular assays.

MR. J. NALLATHAMBI, Junior Research Fellow, Department of Genetics, Aravind Medical Research Foundation, has been awarded the sandwich Ph.D scholarship by French Embassy India, to carry out part of his Ph.D programme in Paris. He underwent research training at Human Molecular Genetics Laboratory, Institut Alfred Jost, Hopital Cochin, Paris, under the guidance of **Prof. Reiner A Veitia** for the

period of four months (September to December 2006). During the training period, functional analysis of *FOXL2* mutations in BPES was carried out and results were published in Human Genetics November 2006. The visit was helpful to develop joined research collaborative projects between two organisations.

Ms. RAMYA DEVI RAMACHANDRAN, Junior research fellow, Department of Molecular Biology, Aravind Medical Research Foundation was awarded the pre-doctoral visiting fellowship to work at the National Eye Institute, NIH, Maryland, USA January 2006 - February 2007. During this period she has been working on the project “Understanding the genetic basis of hereditary cataract in Indian families” under the guidance of Dr. J Fielding Hejtmancik, Chief of Ophthalmic Genetics & Visual Function Branch, wherein she has been trained in carrying out positional cloning of genes involved in inherited diseases and published an article on “Autosomal recessive juvenile onset cataract associated with mutation in BFSP1” Hum Genet. 2007 Jan 16. This visit has been a benefit to our ongoing research activity and will also be helpful in establishing many of the methodologies learned in the AMRF work setting and in building other collaborative projects.

FIRST MEETING OF THE JOINT WORKING GROUP OF INDO-US COLLABORATION ON EXPANSION OF VISION RESEARCH

New Delhi, September 28-29, 2006

This first joint working group meeting was organised by Department of Biotechnology, Government of India. Dr. P. Namperumalsamy, Chairman, Aravind Eye Care System and Dr. VR. Muthukkaruppan, Director, Aravind Medical Research Foundation were invited to attend the meeting. The main objective of the meeting was to discuss and plan for establishing collaboration on expansion of vision research between India and United States of America. Dr. P. Namperumalsamy spoke about the role of Aravind Eye Hospital on overview of Vision Research and Diabetic Retinopathy clinical research network.

Dr. VR. Muthukkaruppan presented the various ongoing research projects as well as the potential of patient materials available for basic research. He has also mentioned about the project (“Will Cytoskeletal drugs prevent Posterior Capsule Opacification?”) which was already approved by National Institute of Health.

The New Indo-US Collaborative projects will be considered for funding by National Institute of Health and by Department of Biotechnology simultaneously.

MAJOR CONFERENCES & TRAINING PROGRAMMES ATTENDED

“Human Genetics and Public Health”
and XXXI Annual Conference of Indian
Society of Human Genetics
New Delhi, Feb27-Mar 01,2006

Poster presentations

J.KANAGAVALLI

- Novel Homozygous mutation in MYOC associated with Indian POAG patient

B.HEMADEVI

- CYP1B1 Gene variations in primary Congenital Glaucoma (PCG) and primary Open Angle Glaucoma

J.NALLATHAMBI

- FOXL2 mutations in Indian families with Blepharophimosis-ptosis – Epicanthus Inversus Syndrome

Indo-Swedish Symposium on Genomics
and Proteomics of Diabetes, Madras on
April 1-2, 2006

P.SUNDARESAN, G. SAJITHLAL, G. SANGILIYANDI,
P.MURUGESWARI, B. SUGANTHALAKSHMI were
participated

Poster presentations

B. SUGANTHALAKSHMI

- Role of VEGF, eNos and ALR gene polymorphisms in diabetic retinopathy

Indian Eye Research Group (IERG)
Meeting

L V Prasad Eye Institute, Hyderabad,
July 20-30, 2006

DR.VR.MUTHUKARUPPAN

- Identification, Enrichment and characterization of Human Corneal Epithelial Stem Cells

GOWRI PRIYA CHIDAMBARANATHAN

- Leptospiral Uveitis is endotoxin mediated

AMALA RAJASUNDARI

- Molecular Study On Congenital Rubella Syndrome In South Indian Population

J.KANAGAVALLI

- Normal And Mutant Myocilin Gene Expression In Cultured Trabecular Meshwork Cells

P.MURUGESWARI & B. SUGANTHALAKSHMI

- Correlation Between Genetic Polymorphisms And Vitreous Levels Of VEGF in Proliferative Diabetic Retinopathy

B.HEMADEVI

- Molecular Genetic Analysis Of Autosomal Recessive Congenital Hereditary Endothelial Dystrophy



Indian Eye Research Group - 2006 at L.V.Prasad Eye Institute, Hyderabad

PUBLICATIONS

ASIAN J.EXP.SCI.

2006;20:15-28

SUGANTHALAKSHMI, RAJENDRAN, KIM, NAMPERUMALSAMY, SUNDARESAN

- *Emerging Patterns of Possible Potential Candidate Gene Polymorphisms Associated with Diabetic Retinopathy – a review*

NATURE GENETICS

2006 Jul; 38 (7):755-7

ERANGA VITHANA, MORGAN, SUNDARESAN, EBENEZER, TAN, ANAND, KHINE, DHIVYA, YONG, SALTO TELLEZ, ANANDALAKSHMI, KE GUO, HEMADEVI, MOIN D. MOHAMED, SRINIVASAN M, PRAJNA, KHINE M, CASEY J, CHRIS F. INGLEHEARN AND TIN AUNG .

- *Mutations in Na⁺-borate co-transporter SLC4A11 cause recessive Congenital Hereditary Endothelial Dystrophy CHED2.*

BMC J OPHTHALMOL

2006, 6:28

NEETHIRAJAN G, NALLATHAMBI J, KRISHNADAS, VIJAYALAKSHMI, SHASHIKANTH, JON MARTIN COLLINSON AND SUNDARESAN

- *Identification of novel mutant PAX6 alleles in Indian cases of familial aniridia,*

MOL VISION

2006; 12:336-41

SUGANTHALAKSHMI B, ANAND R, KIM R, MAHALAKSHMI R, KARTHIKPRAKASH S, NAMPERUMALSAMY P, SUNDARESAN P.

- *Association of VEGF and eNOS gene polymorphisms in type 2 diabetic retinopathy.*

MOL VISION

2006 12: 1086 - 1092

NALLATHAMBI J, SHUKLA, RAJENDRAN, NAMPERUMALSAMY, MUTHULAKSHMI, SUNDARESAN

- *Identification of Novel FZD4 mutations in Indian Patients with Familial Exudative Vitreoretinopathy (FEVR)*

MOL VISION

2006:12:236-42

NALLATHAMBI J, NEETHIRAJAN G, SHASHIKANT S, VIJAYALAKSHMI P, SUNDARESAN P,

- *PAX6 Missense Mutations Associated in patients with Optic Nerve Malformation*

MOL VISION

2006;12:190-5

DEVI RR, VIJAYALAKSHMI P.

- *Novel mutations in GJA8 associated with autosomal dominant congenital cataract and microcornea*

INDIAN J OPHTHALMOL

2007;55:27-31

VASANTHI, NAMPERUMALSAMY, PRAJNA, LALITHA, KANNAN MAHADEVAN, MUTHUKKARUPPAN

- *A Pilot study on the infiltrating cells and cytokine levels in the tear of fungal Keratitis patients.*

CORNEA

2006 (accepted)

ROHINI, MURUGESWARI, PRAJNA, LALITHA, MUTHUKKARUPPAN

- *Matrix Metalloproteinases (MMP-8, MMP-9) and the Tissue Inhibitors of Metalloproteinases (Timp-1, Timp-2) in Keratitis Patients*

CORNEA

2006 (accepted)

PRAJNA, NIRMALA, SARAVANAN, SRINIVASAN

- *An economic analysis of corneal ulcers in South India*

2006 INDIAN J MED RES

2006 Nov;124(5):553-8.

AMALA, KEERTHY, VIJAYALAKSHMI, MUTHUKKARUPPAN

- *Immune Status of Health Care Personnel and Post vaccination analysis of immunity against Rubella in an Eye Hospital"*

J CLIN VIROL

2006; 37:265-8

P.VIJAYALAKSHMI, VR.MUTHUKKARUPPAN, A.RAJASUNDARI, G.KORUKLUOGLU, W.NIGATU, L.A.WARRENER, D.SAMUEL, D.W.G.BROWN

- *Evaluation of a commercial rubella IgM assay for use on oral fluid samples for diagnosis and surveillance of congenital rubella syndrome and postnatal rubella 2006*

HUMAN GENETICS

2006 Nov 7 ; [Epub ahead of print]

NALLATHAMBI J, MOUMNE L, DE BAERE E, BEYSEN D, USHA K, SUNDARESAN P, VEITIA RA.

- *A novel polyalanine expansion in FOXL2: the first evidence for a recessive form of the blepharophimosis syndrome (BPES) associated with ovarian dysfunction.*

HUMAN GENETICS

2006 (In press)

RAMYA DEVI RAMACHANDRAN, VIJAYALAKSHMI PERUMALSAMY, J.FIELDING HEJTMANCIK

- *Autosomal recessive juvenile onset cataract associated with mutation in BFSP1*

MOL VISION

2006 (In press)

BALASUBBU SUGANTHALAKSHMI, DHANANJAY SHUKLA, ANAND RAJENDRAN, RAMASAMY KIM, JEYABALAN NALLATHAMBI, AND PERIASAMY SUNDARESAN

- *Genetic variations in the hotspot region of RS1 gene in Indian patients with Juvenile X-Linked Retinoschisis*

JOURNAL OF GENETICS

2006 (In press)

JEYABALAN NALLATHAMBI GURUSWAMY NEETHIRAJAN, KIM USHA, JETHANI JITENDRA, ELFRIDE DE BAERE, AND PERIASAMY SUNDARESAN

- *FOXL2 mutations in Indian families with Blepharophimosis-Ptosis-Epicanthus Inversus Syndrome*



DR. G. VENKATASWAMY EYE RESEARCH INSTITUTE

Aravind Medical Research Foundation

1, Anna Nagar, Madurai - 625 020, Tamil Nadu, India

Phone: (0452) 435 6100; Fax: 91-452-253 0984

www.aravind.org